



**Pumps**  
Pumps and stopcocks

## Fill off liquids – but do it safely

### Safety is the top priority

Dangerous liquids must never be filled off by directly pouring them out. Even the use of a funnel does not provide the required degree of safety when bottling dangerous liquids.

- ▶ Increased accident risk by slipping on dirty floors.
- ▶ Skin diseases or poisoning by spilt chemicals.
- ▶ Health hazard from harmful vapours.



Safety during bottling must be the number one priority – for your own personal protection!  
This means that purchasing a suitable pump for filling off hazardous

liquids is an investment in the safety and health of your employees which pays for itself in a very short time.

### Choosing the right pump

Apart from the size and type of the container, the required pump capacity and the suitability of the pump for the particular medium are important considerations for choosing the right pump. The pump does not only have to be resistant to the medium to be bottled, but specific occupational safety and environmental protection regulations must also be considered.

### Pump capacity

Electric pumps are the first choice for filling off large quantities at a fixed location. Their higher pumping capacity saves times and requires less manual effort. However, the purchase of an expensive electric barrel pump does not always pay for itself; there is often no on-site mains supply, e.g. in the open air, during assembly or in the equipment storage facility. Manual pumps are an interesting alternative to electric pumps for filling off small quantities due to their independence from a power supply and because they mean value for money. Bürkle offers a wide range of pumping devices for manually removing liquids from containers, canisters, drums and tanks.

### Container size and container type

Pumps that work according to the excess pressure principle are suitable for filling off the required quantities from canisters and closed containers. Air is pumped into the container using a pumping ball or pumping piston. This creates excess pressure in the container and the liquid is transported out via the immersion tube.

Barrel pumps are suitable for larger barrels and open containers. They draw in the liquid and then eject it. This family of pumps is characterised by their robust construction with a good pumping capacity and simple handling. Different immersion tube lengths mean that the pumps fit all the usual commercially available containers. Low-mounted suction valves ensure that almost all the residual liquid is removed.



### Container connections

In contrast to metal drums, which usually have an G 2" fine thread, there are no standard connection threads for plastic drums. There are basically two different ways of attaching the pump to the drum or container. On the one hand, the pump can be screwed onto the existing container thread using a barrel screw joint, possibly in combination with an adapter. On the other hand, universal solutions such as conical drum stoppers can be used.

### Materials

The most suitable pumps are robust industrial pumps made from top-quality materials such as polypropylene (PP) for acids and alkalis, or stainless steel AISI 304 (1.4301) for flammable liquids. We always recommend the use of PTFE seals. Always check that the material is resistant to the medium to be pumped.

In many cases, a check against the chemical resistance list will help.



### Any questions?

We will be happy to advise you. Talk to us – telephone +49 7635 6121-0, or send an email to [info@buerkle.de](mailto:info@buerkle.de).



More information about  
 „Fill off liquids – but do it safely“:  
[www.buerkle.de/en/knowhow/fill-off-liquids-but-do-it-safely](http://www.buerkle.de/en/knowhow/fill-off-liquids-but-do-it-safely)

## OTAL® liquid transfer pumps | filling off liquids quickly, safely and cleanly

The OTAL® pump program has been on the market for 70 years. The pumps are popular and appreciated thanks to their easy handling in daily use.

Thanks to the simple stopper system, OTAL® pumps can be used for all common containers. The OTAL® Mini allows even very small containers to be filled. Only the tube comes into contact with the liquid when OTAL® pumps are used, so that a great deal of liquid can be filled off using the tube materials PP, PVDF and stainless steel AISI 304 (1.4301). The different tube diameters make individual adjustments to required transfer volumes possible.

The OTAL® foot pump has another great advantage, particularly when filling aggressive media. It is designed so that both hands are free during the pumping process.

- ▶ Optionally available as a foot or hand pump
- ▶ Universal bungs for container openings of 30 – 70 mm diameter
- ▶ Tubes made of PE, PP, PVDF or stainless steel AISI 304 (1.4301) for different liquids



### The bung has to fit!

Filling with the proven OTAL® pumps is particularly easy as the liquid is forced out of the container by the excess air pressure. The liquid flow is steady, without pulsating. However, it is important that the connection between the pump and the container is airtight. This is ensured by the universal bung made of soft PVC.

The universal bung consists of 3 parts, a conical centre (1) and 2 conical sleeves (2 and 3) which can be moved up and down the conical centre. This means that it is possible to obtain an airtight seal between OTAL® pumps and container openings with a diameter of 30 to 70 mm.



Instructions for use and safety information must be complied with. Protective clothing must be worn. See pages 51 - 55.

# OTAL® disposable pumps



OTAL pump with disposable delivery tube made of PE, for single use. In OTAL pumps the medium being transferred comes in contact only with the delivery tube. The disposable delivery tube can be replaced quickly and easily after use. There is a danger with reusable pumps that the liquid being transferred will be contaminated by the pump, especially if the pump is used for different media or containers and it is not properly cleaned before the change. A space-saving container pump is specially designed for single use, thereby completely eliminating time-consuming and cost-intensive cleaning as well as contamination. The delivery tube of the liquid transfer pump is made of a single piece and can easily be shortened to the respective container height using the cutter included with delivery. This offers maximum flexibility and guarantees good emptying of small remaining amounts from the container. The discharge of the delivery tube can also be shortened if necessary. The disposable pump is ideal when special purity is important or if cleaning is difficult or not possible at all.

## Use

1. Push the delivery tube into the universal plug and attach the pump ball.
2. Shorten the delivery tube, cutting it off at a slight angle.
3. Build up pressure with the pump ball and transfer the liquid.
4. To replace the delivery tube, cut off the tube directly below the plug.
5. Dispose of the lower end of the tube directly. Pull the upper end out of the universal plug.
6. Insert a new tube.

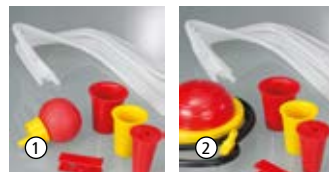

- ▶ Disposable delivery tube made of PE, can be reordered in pack of 10
- ▶ Disposable delivery tubes, can be cut to length individually
- ▶ With universal plug made of soft PVC, for container openings of Ø 30-70 mm
- ▶ Scope of delivery: Pump ball, universal plug, cutter and 10 disposable delivery tubes

① OTAL® disposable hand pump			
Pump capacity approx. l/min	Tube Ø mm	Immersion depth cm	Item no.
14	12	90	5005-8012 N4
② OTAL® disposable foot pump			
Pump capacity approx. l/min	Tube Ø mm	Immersion depth cm	Item no.
14	12	90	5000-8012 N4
Accessories			
Description			Item no.
Delivery tubes PE for OTAL® disposable pumps, 10 pieces			5000-8000 N4

## OTAL® hand pumps | to fit most commercial storage drums

The telescopic immersion tube adapts itself to the container height on insertion. This ensures good removal of residual liquid and means that the hand pump can be used with different containers.

- ▶ Particularly compact, space-saving hand pump
- ▶ Good pump capacity
- ▶ With universal bungs made of soft PVC, for container openings of 30–70 mm Ø

⚠ Attention! Make sure to pay attention to the "List of Chemical Resistance"!



# OTAL® hand pumps | to fit most commercial storage drums

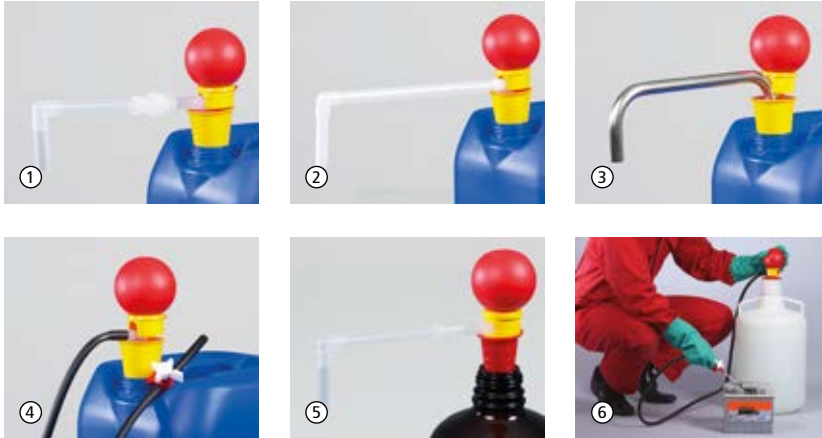

## ① OTAL® hand pump made of PP

OTAL® hand pumps with PP delivery tubes, resistant to weak acids, alkalis and detergents.

## ② OTAL® hand pump made of PVDF

OTAL® hand pump with PVDF delivery tubes, particularly suitable for acids and alkalis, not for heavily oxidising acids and alkalis. With its special material properties, PVDF has an even better chemical resistance than PP. Resistant to chlorine bleach.

## ③ OTAL® hand pump made of stainless steel

OTAL® hand pump with delivery tubes made of stainless steel AISI 304 (1.4301) for liquids that are not easily combustible in Hazard Category AIII (VbF). The OTAL® PP or PVDF hand pump should be used for caustic media.

## ④ OTAL® hand pump with hose and stopcock

OTAL® hand pump with hose and tap with discharge hose with a length of 1.5 m made of PVC and PP/PE stopcock, delivery tube made of PP. The discharge hose is particularly suited to fill distant containers.

## ⑤ OTAL® mini pump made of PP

OTAL® PP mini pump with delivery tubes made of PP and universal bungs made of soft PVC.

- ▶ For small containers, ideal for containers up to 10 litres
- ▶ With universal bungs for container openings of 20–36 mm Ø

## ⑥ OTAL® battery-pump

OTAL® pump for safe filling of car batteries with acid or distilled water.

- ▶ With hose shutoff valve
- ▶ With dosing tip for precise filling

OTAL® hand pump						
	Pump capacity approx. l/min	Tube Ø mm	Delivery tube material	Immersion depth cm	Item no.	
①	14	12	PP	70	5005-1200	N4
①	20	15	PP	70	5005-1500	N4
①	26	18	PP	70	5005-1800	N4
②	20	16	PVDF	70	5005-3000	N4

OTAL® hand pump						
	Pump capacity approx. l/min	Tube Ø mm	Delivery tube material	Immersion depth cm	Item no.	
③	26	18	AISI 304	90	5005-4000	N4
④	12	12	PP/PVC	70	5005-6000	N4
⑤	4	10	PP	45	5005-1000	N4
⑥	5	12	PP/PVC	70	5005-7000	N4

## OTAL® foot pumps | high performance, sturdy, for industrial use



The telescopic immersion tube adapts itself to the container height on insertion of the foot pump. This ensures good removal of residual liquid and means that the foot pump can be used with different containers.

- ▶ Simple handling: Both hands remain free for filling
- ▶ Very good pump capacity due to large volume foot bellows
- ▶ With universal bungs made of soft PVC, for container openings of 30–70 mm Ø

⚠ Attention! Make sure to pay attention to the "List of Chemical Resistance"!



# OTAL® foot pumps | high performance, sturdy, for industrial use



### ① OTAL® foot pump made of PP

OTAL® foot pumps with delivery tubes made of PP, resistant to weak acids, alkalis and detergents.

### ② OTAL® foot pump made of PVDF

OTAL® foot pump with delivery tubes made of PVDF, particularly for acids and alkalis, not for heavily oxidising acids and alkalis. Resistant to chlorine bleach. With its special material properties, PVDF has an even better chemical resistance than PP.

### ③ OTAL® foot pump made of stainless steel

OTAL® foot pump made of stainless steel AISI 304 (1.4301), with delivery tubes made of stainless steel for liquids that are not easily combustible in Hazard Category AIII (VbF).

### ④ OTAL® foot pump with hose and stopcock

OTAL® foot pump with hose and tap with delivery tubes made of PP and a 1.5 m discharge hose made of PVC with stopcock made of PP/PE Ø 10 mm.



### ⑤ OTAL® battery-pump

OTAL® pump for safe filling of car batteries with acid or distilled water.

### ① OTAL® foot pump made of PP



Pump capacity approx. l/min	Tube Ø mm	Delivery tube material	Immersion depth cm	Item no.
20	15	PP	70	5000-1500 N4
26	18	PP	70	5000-1800 N4
30	22	PP	90	5000-2200 N4

	Pump capacity approx. l/min	Tube Ø mm	Delivery tube material	Immersion depth cm	Item no.
②	20	16	PVDF	70	5000-4016 N4
③	26	18	AISI 304	90	5000-5018 N4
④	12	12	PP/PVC	70	5000-3012 N4
⑤	5	12	PP/PVC	70	5005-7000 N4
⑤	5	12	PP/PVC	70	5000-6000 N4

## Pump-it® container pump

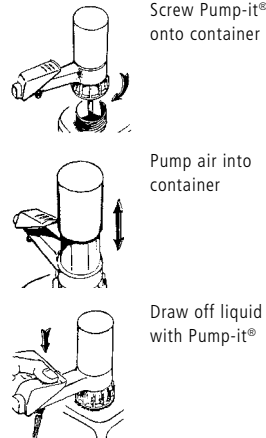

Pump-it® canister pumps are designed for quickly and cleanly emptying canisters and small barrels up to 60 l. The hand pump is used to create excess pressure that forces the liquid out of the canister. Pump-it® is suitable for weak acids, alkalis and petrochemicals.

- ▶ Medium-contacting parts made of PP, PE and FKM
- ▶ Pump threads suitable for container threads 64 mm Ø (BSI)
- ▶ Exact dosing, no drips
- ▶ Container completely emptied, thanks to stepless length adjustment of immersion tube

**⚠** Not suitable for hydrochloric acid! Make sure to pay attention to the "List of Chemical Resistance"!

### Pump-it® container pump

Immersion depth cm	Pump capacity approx. l/min	Item no.
100	8	5201-1000 N4

### Accessories

Description	Item no.
Adapter set Pump-it® consisting of: 0600-3002, -3003, -3004, -1014, -1016	5201-0030 N4
Thread adapters PP outer/outer 2" coarse thread Mauser - 64 mm (BSI)	0600-3004 N4
Thread adapters PP outer/outer 2" coarse thread Tri-Sure - 64 mm (BSI)	0600-3002 N4
Thread adapters PP outer/outer 2" BSP - 64 mm (BSI)	0600-3003 N4
Thread adapters PP outer/inner 64 mm (BSI) - DIN 60	0600-1014 N4
Thread adapters PP outer/inner 64 mm (BSI) - DIN 51	0600-1016 N4
Thread adapters PP outer/inner 64 mm (BSI) - DIN 61	0600-1013 N4
Thread adapters PP outer/inner 64 mm (BSI) - DIN 71	0600-1001 N4

For more adapters, see page 27

## Adapter set Pump-it®



Thread adapter set for Pump-it® canister pump consisting of:

- ▶ Adapter outer/outer, 2" coarse Mauser - 64 mm (BSI), green
- ▶ Adapter outer/outer, 2" coarse Tri-Sure - 64 mm (BSI), brown
- ▶ Adapter outer/outer, 2" BSP - 64 mm (BSI), blue
- ▶ Adapter outer/inner, 64 mm (BSI) - DIN 60, black
- ▶ Adapter outer/inner, 64 mm (BSI) - DIN 51, black

### Adapter set Pump-it®

Item no.	
5201-0030	N4

For more adapters, see page 27

## PumpMaster container pumps | flexible, for universal use

The manual pressure pump is ideally suited for drawing off, decanting and emptying canisters and barrels. The hand pump is used to create excess pressure that forces the liquid out of the container. The stopcock also allows extraction of small quantities of liquid. The PumpMaster container pump is mounted on the container using a flexible stopper with a variable and adjustable diameter. No special thread adapters are required. PumpMaster fits all commercial container openings with a diameter from 46.5 mm to 60 mm. The immersion tube has a length of 95 cm and it can be shortened depending on the size of the container.

► Complete with three bungs in different sizes

**!** Not suitable for hydrochloric acid! Make sure to pay attention to the "List of Chemical Resistance"!

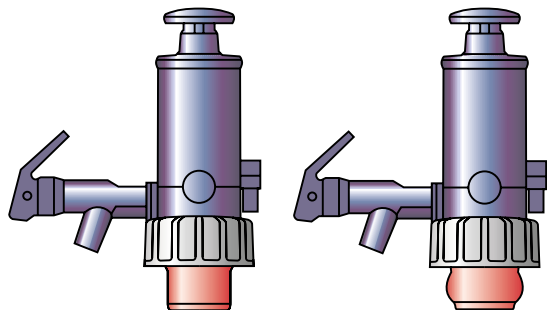

PumpMaster canister barrel pump stopper released

PumpMaster canister barrel pump stopper expanded

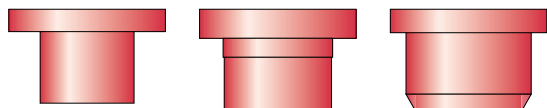

Various stoppers for PumpMaster

### PumpMaster container pump for petrochemical liquids

Gaskets	Material	Colour	Pump capacity approx. l/min	Immersion depth cm	Item no.
NBR	PP	blue grey	8	95	5202-3000 N4

#### Accessories

Description	Item no.
Discharge hose with shut-off valve for PumpMaster for petrochemical liquids	5202-3001 N4

### PumpMaster container pump for non-aggressive liquids

Gaskets	Material	Colour	Pump capacity approx. l/min	Immersion depth cm	Item no.
EPDM	PP	red	8	95	5202-2000 N4

#### Accessories

Description	Item no.
Discharge hose with shut-off valve for PumpMaster for aqueous liquids	5202-2001 N4

### PumpMaster for acids and chemical liquids

Gaskets	Material	Colour	Pump capacity approx. l/min	Immersion depth cm	Item no.
FKM	PP	green	8	95	5202-1000 N4

#### Accessories

Description	Item no.
Discharge hose with shut-off valve for PumpMaster for acids and chemical liquids	5202-1001 N4

# Dosing pumps Dosi-Pump

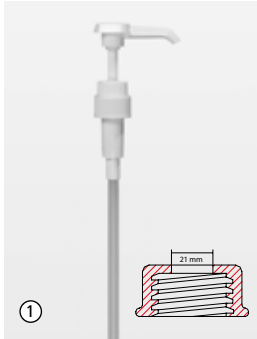

**Dosi-Pump 4 ml**  
Standard dosage approx.  
4 ml per stroke.



**Dosi-Pump 30 ml**  
Standard dosage approx.  
30 ml per stroke.



**Dosi-Pump 30 ml, fixed feeding tube**  
Standard dosage approx.  
30 ml per stroke, the pump has a fixed feeding tube.

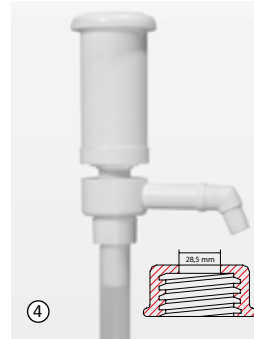

**Dosi-Pump 100 ml, fixed feeding tube**  
Standard dosage approx.  
100 ml per stroke, the pump has a fixed feeding tube.

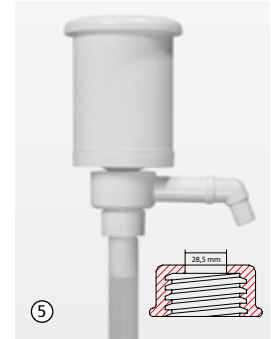

**Dosi-Pump 250 ml, fixed feeding tube**  
Standard dosage approx.  
250 ml per stroke, the pump has a fixed feeding tube.

Dosing pumps suitable for barrels, canisters, carboys or bottles, for dosing liquids of different viscosities. Dosing pumps are mounted by you in your existing container closure (see the locating bore table). To do this, a suitable hole is drilled in the cap. Then the pump is inserted through the hole and screwed in place from below.

A matching container connection is not included in the scope of delivery.

- ▶ Medium-contacting parts made of PP, PE and stainless steel

## Dosing pumps Dosi-Pump



	Stroke approx. ml	Drillhole dia. mm	Immersion depth cm	Item no.
①	4	21	25	5607-1004 N3
②	30	28.5	38.5	5607-2030 N3
③	30	22	33.5	5607-3030 N3
④	100	28.5	29.5	5607-4100 N3
⑤	250	28.5	41.5	5607-5250 N3



# PTFE barrel pumps Ultrapure

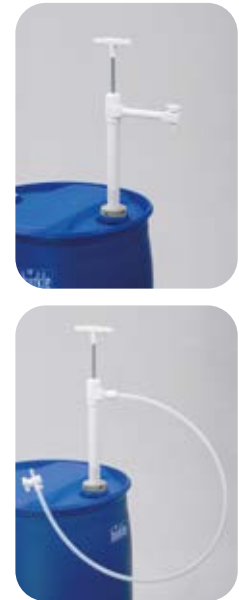

Due to the high chemical resistance of the medium-contacting parts made of PTFE and FEP, even liquids which attack conventional materials such as PP or PVC can now be safely transferred (except for elemental fluorine) with this barrel pump.

The barrel pump is also suitable for transferring ultra-pure liquids. The stopcock prevents hazardous vapours from escaping, and stops dripping after transfer.

Barrel pump with rigid discharge tube with stopcock made of PTFE.

Barrel pump with flexible discharge hose made of PTFE, length of 1.2 m (5606-0401: 60 cm) and stopcock made of PVDF.

- ▶ Immersion tube Ø 32 mm
- ▶ All valves are made of solid PTFE/PVDF
- ▶ Top quality – 3 years' warranty
- ▶ Barrel screw joints for commercially available containers available as accessories

### PTFE barrel pump Ultrapure - discharge tube

Immersion depth cm	Pump capacity ml per stroke	Item no.
40	180	5606-0400 N4
60	270	5606-0600 N4
95	400	5606-1000 N4

### PTFE barrel pump Ultrapure - discharge hose

Immersion depth cm	Pump capacity ml per stroke	Item no.
40	180	5606-0401 N4
60	270	5606-0601 N4
95	400	5606-1001 N4

### Accessories

Description	Item no.
PP barrel screw joint, G 2", steel fine outer thread	5600-3130 N4
PP barrel screw joint, Mauser 2", coarse outer thread	5600-3170 N4
PP barrel screw joint, Tri-Sure, coarse outer thread	5600-3180 N4
Universal thread adapter/AISI 304, Ø 48-75 mm, G2" connector thread	5601-0120 N4
Drum holder for placing filling containers, AISI 304	5618-0200 N4

# PP barrel pumps | robust industrial quality

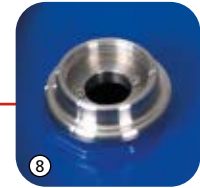
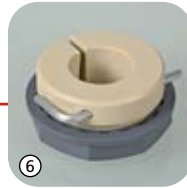

Barrel pumps made of polypropylene allow a fast transfer of liquids from barrels, canisters and tanks. The good chemical resistance of PP allows acids, alkalis and aggressive detergents to be transferred. The low-mounted non-return valve of the barrel pump and the immersion depth that can be steplessly adjusted using the barrel screw joints ensure good removal of residual liquid. The barrel screw joint fastens the barrel's pump securely to the barrel. Barrel screw joints and thread adapters for commercially available containers are available as optional accessories.

**⚠ Attention! Make sure to pay attention to the "List of Chemical Resistance"!**

## PP barrel pumps | robust industrial quality



### PP barrel pump - discharge tube

PP barrel pump with rigid discharge tube.

### PP barrel pump - discharge hose/stopcock

PP barrel pump with flexible discharge hose made of PVC, length of 1.2 m and stopcock.

- ▶ Seals made of PTFE
- ▶ Immersion tube Ø 32 mm
- ▶ Capacity up to approx. 12 l/min
- ▶ For barrels and tanks of 30–1000 litres



#### ① PP barrel pump - discharge tube

Immersion depth cm	Pump capacity ml per stroke	Total length cm	Item no.
50	200	60	5600-0501 N4
65	230	74	5600-0651 N4
80	260	90	5600-0801 N4
100	300	109	5600-1001 N4
125	300	134	5600-1251 N4
150	300	159	5600-1501 N4

#### ② PP barrel pump - discharge hose/stopcock

Immersion depth cm	Pump capacity ml per stroke	Total length cm	Item no.
50	200	60	5600-0502 N4
65	230	74	5600-0652 N4
80	260	90	5600-0802 N4
100	300	109	5600-1002 N4
125	300	134	5600-1252 N4
150	300	159	5600-1502 N4

#### Accessories

Description	Item no.
③ PP barrel screw joint, G 2", steel fine outer thread	5600-3130 N4
④ PP barrel screw joint, Mauser 2", coarse outer thread	5600-3170 N4
⑤ PP barrel screw joint, Tri-Sure, coarse outer thread	5600-3180 N4

#### Accessories

Description	Item no.
⑥ Container screw joint	5600-3140 N4
⑦ PVC barrel plug, dia. 40–70 mm (not for EX zone)	5600-3150 N4
Discharge hose 1.2 m PVC with stopcock for PP barrel pump	5600-0100 N4
⑧ Universal thread adapter AISI 304, Ø 48-75 mm, G2" connector thread	5601-0120 N4
Drain safety stand (see page 50)	5618-1000 N4
Drum holder for placing filling containers, AISI 304	5618-0200 N4

## Stainless Steel Barrel Pump | for flammable liquids



The Bürkle barrel pump made of stainless steel AISI 304 (1.4301) is suitable for filling combustible and easily flammable liquids. The barrel pump can conduct electricity and therefore fulfills the requirements for handling flammable liquids in combination with the accessory antistatic set.

The PTFE gaskets ensure long-term and maintenance-free use. Pumping capacity approx. 9–22 l/min, dependent on pump length.

The wide range of accessories makes it possible to adapt the pump to very different requirements.

Not suitable for acetone!

When withdrawing flammable liquids, the barrel and pump have to be grounded! Use Anti-static set!





# Stainless Steel Barrel Pump | for flammable liquids



## Stainless steel barrel pump - discharge tube

Barrel pump made of stainless steel with discharge tube.

- ▶ Removable discharge tube
- ▶ Immersion tube Ø 32 mm

## Stainless steel barrel pump - discharge hose/stopcock

Barrel pump stainless steel with discharge hose and stopcock made of stainless steel and PTFE, can conduct electricity.

- ▶ Immersion tube Ø 32 mm
- ▶ Removable hose, 1.2 m in length
- ▶ Ball valve made of stainless steel NW 8 mm
- ▶ Discharge nozzle Ø 12.8 mm

### ① Stainless steel barrel pump - discharge tube

Immersion depth cm	Total length cm	Pump capacity ml per stroke	Item no.
36	48	190	5601-0400 N4
57	69	330	5601-0500 N4
91	103	540	5601-0800 N4

### ② Stainless steel barrel pump - discharge hose/stopcock

Immersion depth cm	Total length cm	Pump capacity ml per stroke	Item no.
36	48	190	5601-0401 N4
57	69	330	5601-0501 N4
91	103	540	5601-0801 N4

### Accessories

Description	Item no.
③ Anti-static set	5601-1000 N4
④ Brass barrel screw joint G 2" steel fine outer thread	5601-0100 N4

### Accessories

Description	Item no.
⑤ Gastight barrel connector G 2" steel fine outer thread	5601-0130 N4
Discharge hose 1.2 m with stainless steel/PTFE stopcock	5601-0090 N4
Discharge tube for stainless steel barrel pump	5601-0080 N4
PVC barrel plug, dia. 40–70 mm (not for EX zone)	5600-3150 N4
⑥ Universal thread adapter AISI 304, Ø 48-75 mm, G2" connector thread	5601-0120 N4
Drain safety stand (see page 50)	5618-1000 N4
Drum holder for placing filling containers, AISI 304	5618-0200 N4
PP barrel screw joint, G 2", steel fine outer thread	5600-3130 N4
PP barrel screw joint, Mauser 2", coarse outer thread	5600-3170 N4
PP barrel screw joint, Tri-Sure, coarse outer thread	5600-3180 N4
Universal barrel spanner	5690-0090 N4
Casual style safety goggles	2502-2010 N3



# Solvent pump foot operated



Solvent pump foot operated for filling off high purity liquids such as solvents.

### Pouring flammable liquids

All medium-contacting parts are made of stainless steel AISI 304 (1.4301) and PTFE. The Bürkle anti-static set can be used to ground the pump for dispensing flammable liquids so that no electrostatic charge forms.

### Protection against hazardous vapours

Due to the barrel screw joint and the stopcock, the container and the pump can be hermetically sealed. So that no dangerous vapours can escape after dispensing. This protects both health and the environment.

### Sturdy and practical design

The solid, durable industrial version of the solvent pump ensures a long service life. The pump works according to the overpressure principle. An excess pressure is built up in the tank with the foot actuator, forcing the liquid out of the container. Easy foot operation of the pump with foot actuator leaves both hands free for dispensing. The air hose can be quickly and easily connected and disconnected with the practical clip connection.

- ▶ Immersion tube can be steplessly adjusted to the barrel depth
- ▶ For barrels up to 220 litres
- ▶ Suitable for steel barrels with G 2" thread
- ▶ Thread adapter for commercially available containers and air filters for ultra-pure drawing-off available as accessory

**⚠** When withdrawing flammable liquids, the barrel and pump have to be grounded!  
Use Anti-static set!



Solvent pump foot operated - discharge hose/stopcock			
Immersion depth cm	Connector thread	Pump capacity approx. l/min	Item no.
95	2"	20	5603-3000 N4
Solvent pump foot operated - discharge tube			
Immersion depth cm	Connector thread	Pump capacity approx. l/min	Item no.
95	2"	20	5603-1100 N4
Accessories			
Description			Item no.
Anti-static set			5602-1000 N4
Accessories			
Description			Item no.
Air filters for solvent pump, filter class F5, 10 pieces			0006-6009 N4

# Solvent pump hand operated



Hand-operated solvent pump for contaminationfree removal of organic solvents and flavouring agents. The hand pump works according to the overpressure principle. An excess pressure is built up in the tank with the pump ball, forcing the liquid out of the container.

### Pouring flammable liquids

All medium-contacting parts are made of stainless steel AISI 304 (1.4301) and PTFE. The Bürkle anti-static set can be used to ground the pump for dispensing flammable liquids so that no electrostatic charge forms.

### Gastight version

The pump can be completely closed off with the two ball valves so that no dangerous vapours can escape after dispensing.

### Suitable for different containers

The hand pump is suitable for containers up to 60 litres. The solvent pump for tinfoil canisters has a connector thread for pull-out spouts.

- ▶ Medium-contacting parts made of stainless steel AISI 304 (1.4301) and PTFE
- ▶ Rigid discharge tube with stopcock made of stainless steel/PTFE
- ▶ Suitable for containers with G 2" thread
- ▶ Thread adapter for commercially available containers available as accessory

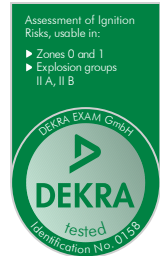

Solvent pump for tin-foil canisters fits on pull-out spouts



Anti-static set

**!** When withdrawing flammable liquids, the barrel and pump have to be grounded! Use Anti-static set!

### Solvent pump hand operated

Immersion depth cm	Connector thread	Pump capacity approx. l/min	Item no.
60	2"	10	5603-1000 N4



### Solvent pump hand operated, for tin-foil canisters

Immersion depth cm	Connector thread	Pump capacity approx. l/min	Item no.
60	for pull-out spout with Ø 35 mm	10	5603-2000 N4



### Accessories

Description	Item no.
Anti-static set	5602-1000 N4

## Withdrawal system for solvents



The withdrawal system can be used to dispense high-purity liquids quickly and without complications. An excess pressure is produced in the container with pressurised gas (compressed air or nitrogen), thereby pumping the liquid out of the tank. The advantage of operation using pressure gas is that the user can extract even large amounts without effort while having both hands free to dispense the solvent. In this way, large amounts of hazardous media such as acetone, ethanol and methanol, etc. can also be safely dispensed and accurately metered using the stop cock. For use with media sensitive to oxygen or for ultra-pure media, operation with an inert gas (e.g. nitrogen) is possible.

The barrel screw connection and shut-off valves seal off the barrel and pump hermetically. This means that no vapours containing solvents can escape after dispensing, thereby protecting users' health and the environment.

The transportable withdrawal system makes it possible to work flexibly. It consists of a barrel pump and attachable pressure regulating unit that adjusts the input pressure and offers additional protection against misuse. A pressure gauge allows for a visual check of the input pressure.

The pump can easily be fastened onto the container with a barrel screw connection. The compressed air or nitrogen connection (3-10 bar) can be provided via a mobile or stationary compressed air supply. The withdrawal system for solvents offers a secure and accurate way to dispense different solvents in laboratory and industrial applications.

**⚠ Caution!** When working with combustible liquids, the tank, pump and pressure regulating unit must be earthed! Use antistatic set in addition for pump!

## Withdrawal system for solvents



The withdrawal system for solvents with discharge tube has a barrel pump with fixed discharge tube. The steplessly adjustable immersion tube of the barrel pump can be adjusted to the respective tank. With barrel screw connection for steel barrels with G 2" thread. Can be adjusted for standard commercial tanks with thread adapters.

In the withdrawal system for solvents with discharge hose, the barrel pump has a flexible discharge hose. The hose makes it possible to dispense the relevant solvent into tanks that are located some distance away and meter it accurately. With barrel screw connection for steel barrels with G 2" thread. Can be adjusted for standard commercial tanks with thread adapters.



- ▶ Flexible connection options, operation with compressed air or inert gas (e.g. nitrogen)
- ▶ Parts in contact with medium made of stainless steel (1.4301) and PTFE
- ▶ Including transport stands, earthing cable for pressure regulating unit, connecting hose, key and adapter for compressed air supply
- ▶ Compressed air supply adapter (G 1/4"): 1x coupling connector NW 7.2 mm, 1x hose nozzle for internal Ø 6 mm, 1x hose nozzle for internal Ø 8 mm
- ▶ For UN tanks and barrels (test pressure at least 150 kpa)
- ▶ The device complies with the requirements of the Pressure Equipment Directive 2014/68/EU

① Withdrawal system for solvents with discharge tube							
Immersion depth cm	Purpose	Pump capacity approx. l/min	Item no.				
60	for tanks up to approx. 60 l	10	5603-5001	N4			
95	for barrels up to approx. 220 l	10	5603-5003	N4			
② Withdrawal system for solvents with discharge hose							
Immersion depth cm	Purpose	Pump capacity approx. l/min	Item no.				
95	for barrels up to approx. 220 l	10	5603-5004	N4			
📦 Accessories							
Description				Item no.			
Anti-static set				5602-1000	N4		

## Mini solvent pump | reliable filling of small quantities

The Mini solvent pump is a high-quality hand pump for small containers such as bottles, canisters and tanks up to about 10 litres. For reliable filling and dosing of solvents and readily flammable liquids.

### Simple principle - highly effective

The hand pump works according to the excess pressure principle. In this way only the hose, pumping tube and discharge come in contact with the liquid being filled. To ensure safety, a pressure relief valve protects the solvent pump against excessive pressure build-up.

### High-quality materials

All parts of this hand pump in contact with medium are manufactured from PTFE and stainless steel AISI 304 (1.4301), AISI 316L (1.4404). The Mini solvent pump is therefore especially well suited for use with high-purity liquids and readily flammable media.

### Filling in hazardous zones

The grounding cable included with delivery can easily be connected to the solvent pump with a bunch plug, thus diverting electrostatic charges so that flammable media can be filled safely.

### Flexible applications

The hand pump has a GL 45 standard connecting thread. With the appropriate thread adapters (accessories), however, it can easily be adapted to containers with thread sizes S 40, GL 38 or GL 32.

### Precise removal of liquids

The self-closing discharge (with auto-stop function) of the Mini solvent pump ensures absolutely precise filling. A hose can optionally be fastened onto the discharge spout (internal Ø 6 mm).

### Well balanced

The Mini solvent pump is very well balanced, which makes it possible to fill without tipping, even from very small containers.

### Sturdiness for long service life

Thanks to its sturdy design and high-quality materials, the Mini solvent pump consistently ensures neat and reliable filling throughout its long service life, easily and conveniently.



- ▶ Ideal for 1–5 l containers
- ▶ Connecting thread GL 45
- ▶ Parts in contact with medium made of PTFE and stainless steel AISI 304 (1.4301), AISI 316L (1.4404)
- ▶ PTFE hose (6x8 mm) 0.4 m
- ▶ Including grounding cable 2 m
- ▶ Adapter available as accessory for S 40, GL 38 and GL 32

### Mini solvent pump

Pump capacity approx. l/min	Connector thread	Item no.
1.8	GL 45	5603-4000 N4

### Accessories

Description	Item no.
Thread adapter for Mini solvent pump, PTFE, GL 45 - S 40	0006-4000 N4
Thread adapter for Mini solvent pump, PTFE, GL 45 - GL 38	0006-4002 N4
Thread adapter for Mini solvent pump, PTFE, GL 45 - GL 32	0006-4003 N4
Hose cutter	0006-9506 N3
Glass sampling bottle 1000 ml, GL 45	5314-0100 N3
Suction hose PTFE on roll 6 x 8 mm, roll with 5 m	8804-0608 N3

## Anti-static set | prevents electrostatic build-up

Conductive containers are connected with the red cable, the black cable makes the earth connection (water pipe, etc.)

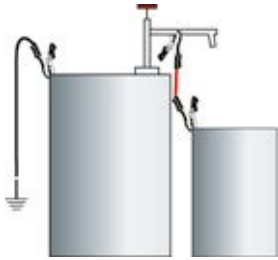

Safety Plus: The bare copper wire ensures earthing when pouring into non-conductive containers

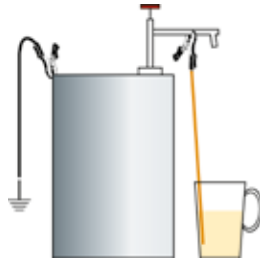

When decanting flammable liquids without the machines and containers involved in the process being sufficiently earthed, electrostatic build-up can occur, which for many substances can result in fire or an explosion. Bürkle's Anti-static set ensures easy and reliable earthing. The Anti-static set consists of three colour-coded connecting copper cables with clamps in a handy plastic case.

Anti-static set

Item no.  
5602-1000



N4

## Barrel screw joints



Barrel screw joint made of nickel-plated brass for barrel pump stainless steel. Prevents electro-static charge in combination with the Anti-static set. For the safe transfer of flammable and easily flammable liquids. For containers with G 2" steel fine thread inside.

### Brass barrel screw joint



Thread	Tube Ø mm	Item no.
G 2" steel fine outer thread	32	5601-0100 N4



The gas tight barrel screw joint prevents hazardous gases from escaping from the barrel. G 2" steel barrel thread, non-return valve with connection 1/8". Nickel-plated brass, seals made of FKM.

### Gastight barrel connector



Thread	Tube Ø mm	Item no.
G 2" steel fine outer thread	32	5601-0130 N4



Universal thread adapter for nearly all drums and other containers with opening of 48–75 mm in diameter, regardless of the respective thread. The thread adapter can be mounted quickly and easily with clamping screws and can be used for different container openings.

With G2" connector thread for Bürkle drum screw connections and pumps with immersion tube diameter up to 32 mm.

### Universal thread adapter



Opening dia. mm	Tube Ø mm	Item no.
48-75	32	5601-0120 N4



Container screw joint to fasten the barrel pump in any location on the side of the container. Also for wide-necked screw caps. The screw joint 2" is screwed on from the inside using lock nut 2". (Mounting holes in the container 60 mm).

### Container screw joint



Opening dia. mm	Tube Ø mm	Item no.
60	32	5600-3140 N4



Barrel screw joint made of PP for secure connection in the barrel in three different thread models. For drawing off liquids that are not flammable.

### PP barrel screw joint



Thread	Tube Ø mm	Item no.
G 2", steel fine outer thread	32	5600-3130 N4
Mauser 2", coarse outer thread	32	5600-3170 N4
Tri-Sure, coarse outer thread	32	5600-3180 N4



Barrel bungs made of PVC, consisting of two parts, therefore can be used for various openings with a diameter from 40–70 mm.

### PVC barrel plug



Opening dia. mm	Tube Ø mm	Item no.
40–70	32	5600-3150 N4



# Thread adapters



Thread adapter stainless steel, for flammable liquids



We offer a broad range of thread adapters. This facilitates the secure connection of many of our pumps and discharge cocks to a variety of containers.

You will always find the correct connection thanks to the combination of different adapters.

Do you have any questions about choosing the right thread adapter? Please call us. We are glad to offer assistance.

Instructions for determining the thread can be found on page 276.

	External thread	Internal thread	Colour	Item no.
①	S 56x4 (Tri-Sure)	G 2"	orange	0600-1006 N4
②	S 70x6 (Mauser)	G 2"	blue	0600-1010 N4
③	S 56x4 (Tri-Sure)	S70x6 (Mauser)	red	0600-1011 N4
④	S 70x6 (Mauser)	S 56x4 (Tri-Sure)	purple	0600-1012 N4
⑤	BSF 2 1/2" (US barrel)	G 2"	silver	0600-1007 N4
⑥	S 61x6 (DIN 61)	G 2"	grey	0600-1008 N4
⑦	S 61x6 (DIN 61)	S 96x8 (DIN96)	natural	0600-1009 N4
⑧	S 64x5	S 60x6 (DIN60)	black	0600-1014 N4
⑨	S 64x5	S 55x5 (DIN51)	black	0600-1016 N4
⑩	S 64x5	S 61x6 (DIN61)	yellow/blue	0600-1013 N4
⑪	S 64x5	S 71x6 (DIN71)	brown/blue	0600-1001 N4
	Internal thread	Colour	Item no.	
⑫	35 mm (double-threaded) / G 2"	black	0600-2004 N4	
⑬	S 40x3 / G 2"	black	0600-2012 N4	
⑭	S 55x5 (DIN51) / G 2"	green	0600-2005 N4	
⑮	S 61x6 (DIN 61) / G 2"	yellow	0600-2001 N4	
⑯	S 63x4 / G 2"	white	0600-2006 N4	
⑰	S 71x6 (DIN71) / G 2"	brown	0600-1003 N4	
⑳	G 1 1/2" / G 2"	Stainless steel	0600-3100 N4	
	External thread	Colour	Item no.	
⑱	S 61x6 (DIN61) / S 56x4 (Tri-Sure)	black/orange	0600-3006 N4	
㉑	S 61x6 (DIN61) / G 2"	black	0600-3007 N4	
㉒	S 70x6 (Mauser) / S 64x5	green	0600-3004 N4	
㉓	S 56x4 (Tri-Sure) / S 64x5	brown	0600-3002 N4	
㉔	G 2" / S 64x5	blue	0600-3003 N4	
㉕	Adapter set, consisting of 1,2, 15 and 17		0600-3010 N4	

## Gas-tight barrel pump PP | odour-free liquid transfer

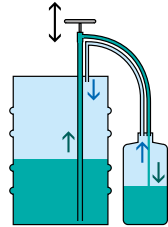

Liquid is pumped in the closed system (green). Vapours are directed back through the gas displacement line (blue)



- ▶ Medium-contacting parts PP, PE and PVC
- ▶ Steplessly extendable telescopic tube
- ▶ For barrel depths of 40–67 cm
- ▶ Two adapters for original containers

The gas-tight barrel pump enables odour-free transfer.

During transfer with normal pumps, it is impossible to prevent vapours escaping into the atmosphere. The gas-shuttle method avoids this. Any vapours produced are returned from the container which is to be filled to the original container via the gas-shuttle pipe. The gas pipe and the liquid pipe are additionally provided with stopcocks. Gas-tight pumps are used for substances that have a strong smell such as ammonia.

### Gas-tight barrel pump PP

Model	Pump capacity ml per stroke	Item no.		
① with universal adapter 34–70 mm Ø	200	5610-1030	N4	
② with 2 screw joint adapters 3/4" with lock nuts	200	5610-1040	N4	

## Gas-tight stainless steel pump



Gas tight barrel pump with flexible discharge hose for filling off into large canisters and containers. Convenient transfer because the canister can stay on the floor. The connection cone is held onto the container.

- ▶ Parts in contact with media: Stainless steel AISI 304 (1.4301), PTFE
- ▶ Incl. gas-tight barrel screw joints with 2" fine thread
- ▶ For bottle openings from 16–49 mm
- ▶ Immersion tube Ø 32 mm
- ▶ The pump can be hermetically sealed with two ball valves

Pump has been developed in cooperation with Ludwig-Maximilians University, Munich.

Not suitable for acetone! When withdrawing flammable liquids, the barrel and pump has to be grounded! Use Anti-static set!

### Gas-tight stainless steel barrel pump

Immersion depth cm	Total length cm	Pump capacity ml per stroke	Item no.	
57	69	330	5611-1090	N4
91	103	540	5611-0090	N4

## Lever pump aluminium



Lever pump for petrochemical substances made of stable aluminium cast, valves and pistons are made of plastic (PA).

- ▶ Suitable for barrel threads M 64x4 or G 2"
- ▶ With closure device (for padlock)
- ▶ Immersion tube length 84 cm
- ▶ Supplied with hose kit, hose length 1.5 m, electrically conductive, with outlet elbow and bend protection spring

### Lever pump aluminium

Pump capacity approx. l/min	Pumping height water column m	Connector thread	Item no.
25	1	M 64x4, G 2"	5627-1000 N2

### Accessories

Description	Item no.
Anti-static set	5602-1000 N4

## Piston pump PP



Piston pump for watery and petrochemical products. It represents value-for-money. The piston pump is attached to the barrel using a 2" - or 3/4" barrel thread. After mounting, the pump can still be rotated around its axis so that containers to be filled can be placed on the barrel lid.

- ▶ Polypropylene, polyethylene, seals made of NBR
- ▶ Pump capacity adjustable from 100, 250, 350 and 500 ml per stroke
- ▶ For containers with G 2" and G 3/4" inner thread
- ▶ Immersion tube length 84 cm

**!** Attention! Make sure to pay attention to the "List of Chemical Resistance"!

### Piston pump PP

Description	Item no.
Anti-static set	5613-0030 N4

## Compact lever pump

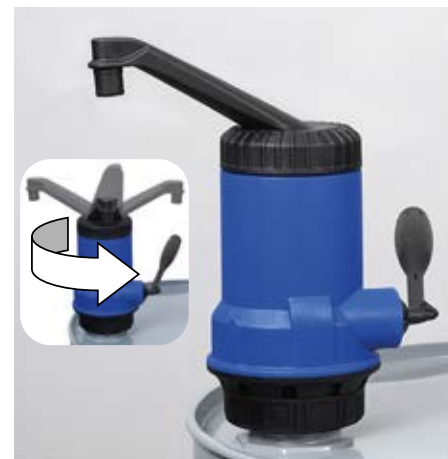

Compact, self-priming polypropylene lever pump suitable for light acids and bases. The telescope tube for lever pump is steplessly extendable up to 100 cm, which means it can be used for barrels from 50 to 200 l.

- ▶ Polypropylene, seals made of NBR
- ▶ Pump capacity up to about 500 ml per stroke
- ▶ Discharge tube can be rotated 360°
- ▶ With integrated barrel screw connection for G2" thread

**!** Attention! Make sure to pay attention to the "List of Chemical Resistance"!

### Compact lever pump

Description	Item no.
Immersion depth cm	5613-0020 N4

# Lever pump



### Lever pump with galvanised steel piston rod

The lever pump is made of polypropylene with a galvanised steel piston rod and FKM seals.

### Lever pump with stainless steel piston rod

The lever pump is made of polypropylene with a stainless steel piston rod made of AISI 304 (1.4301) and FKM seals.

The required quantities can be taken from barrels without great effort with this manual lever pump. Ideal for occasional use.

Applications of the lever pump: water, lubricants, light oils, water-based chemicals and light acids and caustic solutions.

- ▶ With integrated barrel screw connection for 1 1/4" and 2" fine thread
- ▶ Pump capacity 350 ml per stroke
- ▶ Immersion depth steplessly variable from 65–90 cm

Note the "List of Chemical Resistance"!

<b>Lever pump with galvanised steel piston rod</b>			
Colour	blue	Item no.	5613-0040 N4
<b>Lever pump with stainless steel piston rod</b>			
Colour	yellow	Item no.	5613-0041 N4

## Siphon with stopcock | for occasional drawing off of liquids



Device for easy operation to quickly fill off watery liquids from containers higher up to containers lower down.

Works according to the siphoning principle: Liquid needs only to be primed once, therefore especially handy for complete emptying of a container.

- ▶ LDPE/PVC
- ▶ Pump capacity 9 l/min
- ▶ With robust ball valve made of PP
- ▶ Good view of medium due to transparent hoses
- ▶ Bend protection for the hose with suspension eyelet
- ▶ Cost-effective filling unit if drawing-off does not need to take place regularly

Offered also as rigid immersion tube upon request.



### Siphon with stopcock

Material	Immersion depth cm	Hose inner dia. mm	Pump capacity approx. l/min	Item no.
LDPE/PVC/PP	100	15	9	5605-1000 N4



## AccuOne / EnergyOne | Flexible – reliable – convenient – with the hybrid system

One pump with maximum possibilities.

Bürkle barrel pumps AccuOne and EnergyOne with the unique hybrid system ensure fast, flexible and convenient filling whenever and wherever you want. The pumps are equipped with two different power supply systems:

AccuOne, driven by a high-performance rechargeable battery or EnergyOne, with a power cable for direct connection to the electrical network.

### The innovative feature: The power supply units are interchangeable!

The rechargeable battery or the power supply unit are fitted with a clip lock and are removable. They can be exchanged quickly and easily. Thus AccuOne can also be operated with the power supply cable unit and EnergyOne can be operated with the rechargeable battery. With an exchange battery as an accessory, you can also reduce the number of charging breaks.

The drive can also be disconnected quickly and easily from the pump station with a clip lock. This makes it possible to use one drive for filling at several stationary pump stations. AccuOne and EnergyOne are designed for applications in which even very small amounts of liquid can be added to small containers with narrow openings.

The touch panel features a foil keyboard sealed off against dust, dirt and water. The keyboard can be used to regulate the flow rate continuously from 0.4 l/min to 12 l/min.

In addition to the drainage elbow, a flexible drainage hose with nozzle is optionally available. The light and powerful pumps are made of high-quality materials, PP, PTFE and Hastelloy C, to ensure outstanding chemical resistance. This also makes them suitable for dispensing acids and bases. Please make note of detailed information related to chemical resistance!

Attention! Make sure to pay attention to the "List of Chemical Resistance"!

Do not use in EX area!

- ▶ Unique hybrid system – rechargeable battery and power supply unit are interchangeable
- ▶ Drive unit can be easily disconnected
- ▶ TouchPanel for precise flow regulation
- ▶ Excellent residual draining and pumping capacity
- ▶ One drive for several pump stations
- ▶ Outstanding chemical resistance



Battery can be easily disconnected



Power supply unit can be easily disconnected



Drive unit can be easily disconnected



Touch panel



Power supply unit incl. connector



Charger for battery



## AccuOne barrel pump



More accessories on page 34

The barrel pump driven by rechargeable battery, AccuOne, features a unique hybrid system with complete flexibility and independence from the electrical network. A powerful light rechargeable battery with the latest next generation lithium-ion technology, without memory effect, with auto-stop function before deep discharge.

- ▶ Lithium-ion rechargeable battery
- ▶ Up to 1500 litres of delivery volume per battery charge, replacement back-up battery available
- ▶ Optionally available with rechargeable battery or power supply unit (available as accessory)
- ▶ Consisting of pump station, drive, rechargeable battery, charger and fixed discharge elbow

### AccuOne barrel pump driven by rechargeable battery



Immersion depth cm	Item no.
50	5900-1050 N4
70	5900-1070 N4
100	5900-1100 N4

#### Accessories

Description	Item no.
PP barrel screw joint, G 2", steel fine outer thread	5600-3130 N4
PP barrel screw joint, Mauser 2", coarse outer thread	5600-3170 N4
PP barrel screw joint, Tri-Sure, coarse outer thread	5600-3180 N4

## EnergyOne barrel pump



More accessories on page 34

The barrel pump driven by power supply unit, EnergyOne, features a unique hybrid system with complete flexibility and independence from battery charging.

- ▶ Power supply via 230 V power supply unit, international plug adapter included with delivery
- ▶ Optionally available with power supply unit or rechargeable battery (available as accessory)
- ▶ Consisting of pump station, drive, power supply unit incl. connector and fixed discharge elbow

### EnergyOne barrel pump driven by power supply unit



Immersion depth cm	Item no.
50	5900-2050 N4
70	5900-2070 N4
100	5900-2100 N4

#### Accessories

Description	Item no.
PP barrel screw joint, G 2", steel fine outer thread	5600-3130 N4
PP barrel screw joint, Mauser 2", coarse outer thread	5600-3170 N4
PP barrel screw joint, Tri-Sure, coarse outer thread	5600-3180 N4

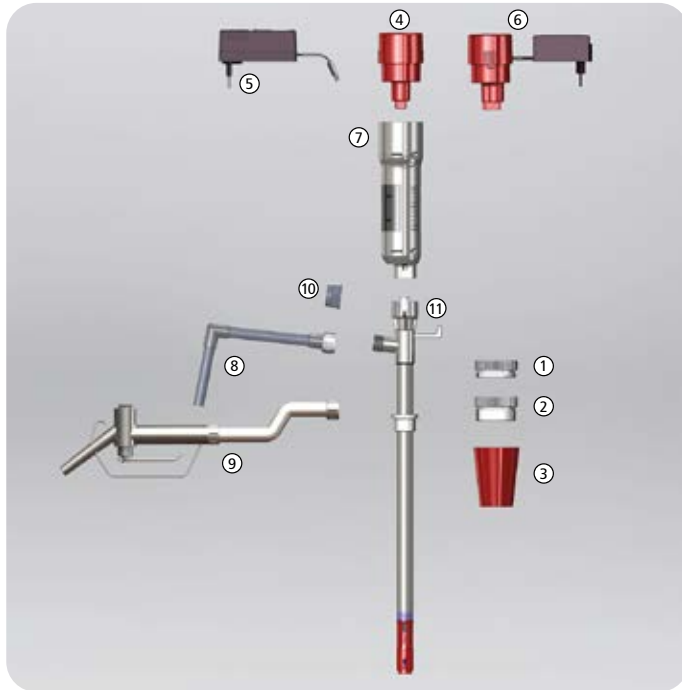

Light- and high-performance pump to transfer watery media up to 300 mPas from canisters, barrels and narrow-necked containers from 32 mm opening diameter.

- ▶ PP
- ▶ Splash-water protected motor 230 V/200 W (IP44)
- ▶ Built-in safety key as on/off switch
- ▶ Seal-less pump mechanism for acids and alkalis
- ▶ Thread connection 1" with hose connector 3/4"
- ▶ Incl. 1.5 m PVC hose 3/4", PP nozzle and wall bracket

**!** Attention! Make sure to pay attention to the "List of Chemical Resistance"!

Laboratory pump mains operated							
Immersion depth cm	Pump capacity approx. l/min	Pumping height water column m	Tube Ø mm	Item no.			
70	75	7	32	5700-2200 N2			
100	75	7	32	5700-4400 N2			

Accessories	
Description	Item no.
Flow meter PP 1" (see page 38)	5700-0111 N2

### Accessories

Description	Item no.
① PP barrel screw joint, G 2", steel fine outer thread	5600-3130 N4
① PP barrel screw joint, Mauser 2", coarse outer thread	5600-3170 N4
① PP barrel screw joint, Tri-Sure, coarse outer thread	5600-3180 N4
② Container screw joint	5600-3140 N4
③ PVC barrel plug, dia. 40 – 70 mm (not for EX zone)	5600-3150 N4
④ Rechargeable battery without charger for Accu/EnergyOne	5900-3010 N4
⑤ Charger for battery Accu/EnergyOne	5900-3015 N4
⑥ Power supply unit incl. connectors for Accu/EnergyOne	5900-3020 N4
⑦ Drive without rechargeable battery/power supply unit	5900-3030 N4
⑧ Discharge tube	5900-3040 N4
⑨ Discharge hose 1.2 m, with nozzle (PVC, PP, AISI 304, FKM)	5900-3045 N4
⑩ Closing cap thread 3/4"	8535-0034 N3
⑪ Pump station Accu/EnergyOne, submersible length 50 cm	5900-3050 N4
⑪ Pump station Accu/EnergyOne, submersible length 70 cm	5900-3070 N4
⑪ Pump station Accu/EnergyOne, submersible length 100 cm	5900-3100 N4



# Electric barrel pump Petro | for Diesel oil, class D/II fuel oil



Electric barrel pump for pumping diesel oil, Category EL fuel oil, undiluted radiator antifreeze and other liquids of Hazard Category AIII (VbF).

Built-in siphon protection prevents leaks if the tube is faulty. Available for 230 V. Available with either standard filling nozzle or filling nozzle with automatic shut-off. Electronic volume readout with cumulative total and suitable for calibration (supplied uncalibrated), available as accessory.

- ▶ With manual suction pump
- ▶ VDE tested, motor with thermal protection switch
- ▶ Barrel thread M 64x4 and 2"
- ▶ Suction hose with filter 1.60 m length
- ▶ Pump hose made of Perbunan, 4 m length, with bend protection spring and pump nozzle

Not suitable for aqueous/diluted liquids!



Volume readout Petro

## Electric barrel pump Petro

2 weeks

Model	Pump capacity approx. l/min	Item no.
standard	40	5780-0040 N2
automatic	40	5780-0041 N2

### Accessories

Description	Item no.
Volume readout Petro	5780-0020 N2

## Drum pump for acids and alkalis



Barrel pump for weaker acids, such as phosphoric acid, chromic acid, battery acid, citric acid, etc.

- ▶ Motor 230 V
- ▶ Pump tube PP, shaft Hastelloy C
- ▶ Thread connection 1 1/4" with hose connector 3/4"
- ▶ 2 m PVC fabric hose 3/4"
- ▶ PP pump nozzle
- ▶ PP barrel screw joint
- ▶ Pump height 19 mWS, pump capacity 85 l/min

**⚠** Not suitable for hydrochloric acid! Make sure to pay attention to the "List of Chemical Resistance"!

Drum pump for acids and alkalis			
Immersion depth cm	Tube Ø mm	Item no.	
100	41	5762-0100 N2	
120	41	5762-0101 N2	
Accessories			
Description		Item no.	
Flow meter PP 1 1/4" (see page 38)		5700-0121 N2	

## Drum pump for concentrated acids/alkalis



Barrel pump for highly aggressive acids and alkalis, such as sulphuric acid, nitric acid, hydrofluoric acid, sodium hypochlorite etc.

- ▶ Motor 230 V
- ▶ PVDF pump tube
- ▶ Thread connection 1 1/4" with hose connector 3/4"
- ▶ 2 m special chemical hose 3/4"
- ▶ PVDF pump nozzle
- ▶ PP barrel screw joint
- ▶ Pump height 17 mWS, pump capacity 80 l/min

**⚠** Not suitable for hydrochloric acid! Make sure to pay attention to the "List of Chemical Resistance"!

Drum pump for concentrated acids/alkalis			
Immersion depth cm	Tube Ø mm	Item no.	
100	41	5762-0200 N2	
120	41	5762-0201 N2	
Accessories			
Description		Item no.	
Flow meter PVDF 1 1/4" (see page 38)		5700-0141 N2	

## Drum pump for mineral oils



Barrel pump for light viscous mineral oil products, such as diesel, fuel oil, hydraulic fluid, machinery and motor oil, etc.

- ▶ Motor 230 V
- ▶ Pump tube made of aluminium
- ▶ Hose connection Alu 1"
- ▶ 2 m PVC fabric hose 1"
- ▶ Hose clips 1"
- ▶ Alu pump nozzle, PP barrel screw joint
- ▶ Medium-contacting parts made of aluminium and AISI 316 Ti (1.4571)
- ▶ Delivery pump height 19 mWS, Pump capacity 85 l/min

**!** Attention! Make sure to pay attention to the "List of Chemical Resistance"!

### Drum pump for mineral oils



Immersion depth cm	Tube Ø mm	Item no.
100	41	5763-0100 N2

## Drum pump for solvents



Barrel pump for highly flammable hydrocarbons such as ethanol, benzene, butanol, isopropanol, kerosene, methanol, etc.

- ▶ Motor 230 V
- ▶ Pump tube made of stainless steel
- ▶ Voltage balancing cable
- ▶ Hose electrically-conductive
- ▶ 2 m solvent hose 3/4"
- ▶ Brass pump nozzle
- ▶ PP barrel screw joint
- ▶ Delivery pump height 14 mWS, pump capacity 95 l/min

**!** Attention! Make sure to pay attention to the "List of Chemical Resistance"!

### Drum pump for solvents



Immersion depth cm	Tube Ø mm	Item no.
100	41	5763-0301 N2

## Flow meters



Compact electronic flow counter for electrical barrel and container pumps. For thin fluid media.

- ▶ Measuring according to the turbine wheel principle
- ▶ Counter can be calibrated depending on the medium
- ▶ Different versions for many different applications
- ▶ Automatic switch-on when flow is recognised
- ▶ Measuring accuracy  $\pm 1\%$ , easy recalibration
- ▶ Two 1.5 V batteries (AAA), exchangeable
- ▶ For use up to max. 10 bar (20 °C)
- ▶ Range of viscosity 0,8 – 40 mPas
- ▶ Temperature -10 °C up to +50 °C

Flow meter				
Material	Model	Measuring range l/min	Connector thread	Item no.
PP, Hastelloy C22, PTFE	for fuel oil, diesel, sod. hydroxide, etc.	5 - 120	G 1 1/4"	5700-0121 N2
PP, Hastelloy C22, PTFE	for fuel oil, diesel, sod. hydroxide, etc.	5 - 120	G 1"	5700-0111 N2
PVDF, Hastelloy C22, PTFE	for highly aggressive liquids like chlorine bleaches, nitric acid, sulfuric acid, etc.	5 - 120	G 1 1/4"	5700-0141 N2

## Double-diaphragm pump 1/4"



Air-operated double diaphragm pump for pumping viscous, corrosive and abrasive liquids. The plastic double diaphragm pump is suitable for pumping small quantities, in the laboratory and for occasional filling. Suction and discharge connections are 1/4" internal. Solid particles up to 3 mm  $\varnothing$  can be pumped. Housing, diaphragms, valve balls and seals are available in different materials. Required air pressure at start-up min. 2 bar, operating air pressure max. 8 bar.

- ▶ High hydraulic performance
- ▶ Maintenance-optimised design and simple installation
- ▶ Blockage-free operation
- ▶ Absolutely oil-free
- ▶ Self-priming (even in dry condition)



Double diaphragm pump 1/4"			
Material	Pump capacity approx. l/min	Pumping height water column m	Item no.
Diaphragms/valve balls/seals: NBR, valve seat/housing: PP	52	4	5765-0001 N2
Diaphragms: TPC-ET + TFM (PTFE), valve balls/seals: PTFE, valve seat/housing: PP	52	4	5765-0002 N2
Diaphragms: TPV (EPDM-PP), valve balls/seals: EPDM, valve seat/housing: PP	52	4	5765-0003 N2
Diaphragms: TPV (EPDM-PP) + TFM (PTFE), valve balls/seals: PTFE, valve seat/housing: PVDF	52	4	5765-0004 N2

## Magnetic centrifugal pumps



The magnetic centrifugal pumps are suitable for transferring acids, alkalis, alkaline and electroplating baths, photography chemicals as well radioactive, sterile and highly corrosive liquids. The drive, via contact-free magnetic force transfer, requires no dynamic shaft seals and this makes a hermetically sealed pump housing possible, which means that it cannot leak.

- ▶ Seal-less
- ▶ Surrounding temperature max. 45 °C
- ▶ Operating temperature max. 60 °C
- ▶ Viscosity max. 20 mPas

Magnetic centrifugal pump 15 Watts, motor 230 V, material PP (reinforced with fibre glass), stainless steel (shaft), Rulon (bearing), FKM (seal).

- ▶ Pump capacity 1 to 12 l/min, delivery height up to 2 m
- ▶ Without thread, hose nozzle 14 mm

Magnetic centrifugal pump 29 Watts, motor 230 V, material PP (fibre glass reinforced), stainless steel, Rulon (bearing), FKM (seal), ceramics (shaft).

- ▶ Pump capacity 1 to 24 l/min, delivery pump height up to 3 m
- ▶ Suction connection / pressure connection G 3/4" outer thread (BSP)

### Magnetic centrifugal pump



Model	Item no.
① 15 Watt, no thread connection, with tubing nozzle	5766-0001 N2
② 29 Watt, with R 3/4" outer thread	5766-0002 N2

## AirJet Mini membrane vacuum pump



The AirJet Mini single-head membrane vacuum pump is suitable for a variety of applications in the laboratory and industry. The dry running membrane vacuum pump is able to pump, compact and evacuate 100 % oil-free, which means it does not distort results or add impurities, and can also be used as a compressor. The AirJet Mini is used to pump and evacuate air and neutral or slightly aggressive or corrosive gases and vapours.

- ▶ Weight 1.9 kg, dimensions LxWxH 164/90/141 mm
- ▶ Hose connection ID 4 mm
- ▶ Maintenance-free, environmentally friendly
- ▶ High level of gas tightness
- ▶ Very quiet with low vibrations

**!** Attention! Make sure to pay attention to the "List of Chemical Resistance"!



### ① AirJet Mini membrane vacuum pump/compressor



Model	Pump capacity approx. l/min	Vacuum mbar	Pressure max. bar	Item no.
Membrane made of EPDM	6	100	2.4	5625-2000 N2
Membrane made of PTFE	5.5	160	2.5	5625-2001 N2

### Accessories

Description	Item no.
② AirJet Mini fine regulation head	5625-2002 N2
③ AirJet Mini sound absorber	5625-2003 N2

# StopCocks | completely water-tight, easily operated

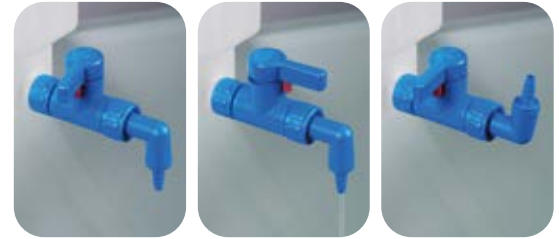

Stopcock angled

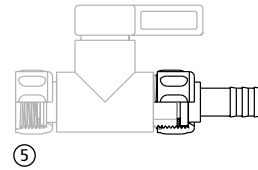
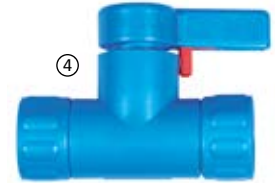
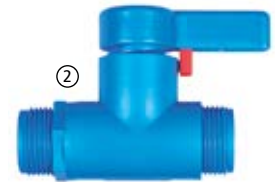
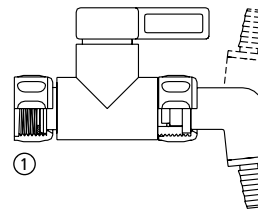

Various designs of the stopcock. Connecting thread 3/4" with union nut or external thread

The StopCock discharge cocks fit all containers with G 3/4" connection threads. Thread adapters facilitate connection of cocks to nearly all containers.

- ▶ Tight-closing for complete seal
- ▶ Especially effortless
- ▶ With connecting cap nut, guaranteed vertical position of the cock
- ▶ Pressure-resistant up to 2 bar at 20 °C (without discharge bracket and grommet)

- ▶ With discharge angle and rotatable spout preventing drips
- ▶ With tapered spout for bottles with narrow openings with a diameter from 6 to 8 mm.
- ▶ Media-contacting parts PP, PE and PTFE

Not suitable for crystallising substances!

## StopCock angled

Thread, inflowing side	Thread, outflowing side	Item no.
① 3/4" inner thread cap nut	spout/nozzle	0525-1000 N4

## StopCock straight-through

Thread, inflowing side	Thread, outflowing side	Item no.
② 3/4" outer thread	3/4" outer thread	0525-3000 N4
③ 3/4" inner thread cap nut	3/4" outer thread	0525-5000 N4
④ 3/4" inner thread cap nut	3/4" inner thread cap nut	0525-7000 N4

## Accessories

Description	Item no.
⑤ Hose nozzle StopCock 4 mm	0525-1304 N4
Hose nozzle StopCock 6 mm	0525-1306 N4
Hose nozzle StopCock 8 mm	0525-1308 N4
Hose nozzle StopCock 10 mm	0525-1310 N4
Hose nozzle StopCock 12 mm	0525-1312 N4
Hose nozzle StopCock 16 mm	0525-1316 N4
Discharge angle	0525-1400 N4

## Compact spigot



The spigot Compact for canisters and barrels captivates everyone through its compact build, which makes the valve on the canister ideal for use in refrigerators and on racks, etc. The short discharge does not protrude out over the lower edge of the container, which makes the valve a perfect choice even when space is very limited.

The discharge's specially optimised design creates an even stream of liquid with no splashing or spattering. The spigot features easy motion and a tight seal. It is screwed on with a connecting cap nut. This guarantees a vertical position of the valve and makes it possible to adjust the valve later on.

The Compact spigot fits all containers with G 3/4" connecting threads.

PP, PE and PTFE are materials that offer outstanding chemical resistance to acids and alkalis.

The Compact spigot is the ideal addition to the compact jerrycans – for perfect storage and filling when space is at a premium!

- ▶ Space-saving design
- ▶ Optimised discharge for even flow
- ▶ With connecting union nut for vertical position of the stop cock
- ▶ Tight-closing for complete seal



### Compact spigot

Thread, inflowing side  
3/4" inner thread cap nut



Item no.  
0530-1000 N4

## Compact jerrycan & StopCock set

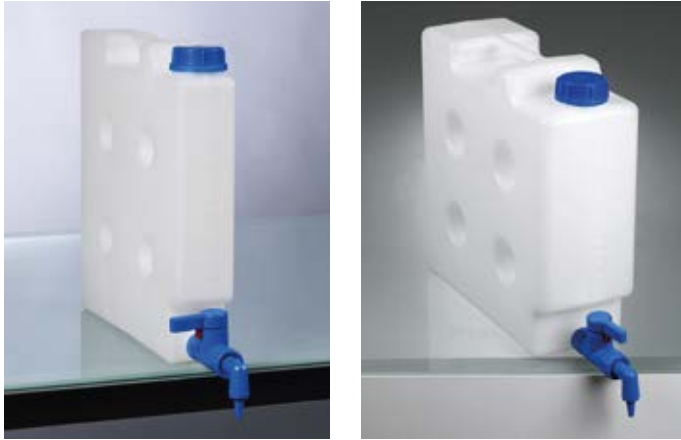

The Compact jerrycan & StopCock set consists of the compact jerrycan with glands 5 l (0435-2050) or 10 l (0435-2100) and the spigot StopCock (0525-1000).

## Compact jerrycan & Compact stop cock set

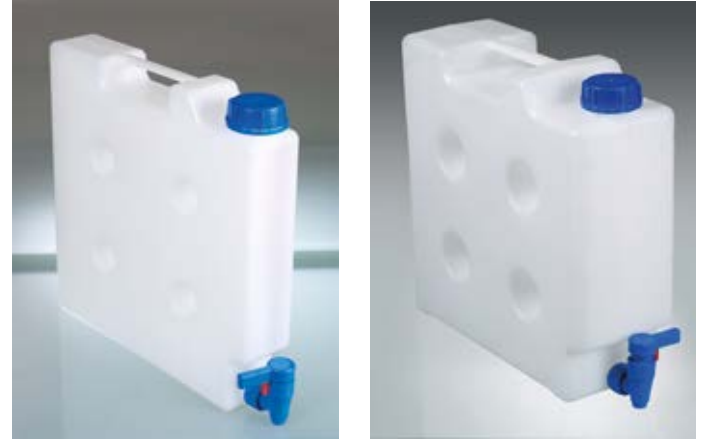

The Compact stop cock is the ideal addition to the compact jerrycan – for perfect storage and filling when space is at a premium! The space-saving set consists of the compact jerrycan with glands 5 l (0435-2050) or 10 l (0435-2100) and the spigot Compact (0530-1000).



### Compact jerrycan & StopCock set



Capacity l	Item no.
5	0435-0001 N4
10	0435-0010 N4

### Compact jerrycan & Compact stop cock set



Capacity l	Item no.
5	0435-3000 N4
10	0435-3010 N4



## Compact jerrycan set, electroconductive



The electrically conductive compact jerrycan set consists of a compact jerrycan with a capacity of 5 litres (0435-2055 ) or 10 litres (0435-2105) and a StopCock PA (0525-1100). The stopcock and canister can be earthed with an anti-static set and can therefore be used in explosion-proof areas.

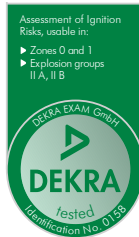

**⚠ Caution!** When working with combustible liquids, the canister must be earthed! Use anti-static set!

Compact jerrycan set, electroconductive			
Capacity l	Item no.		
5	0435-0005 N4		
10	0435-0015 N4		
Accessories			
Description	Item no.		
Anti-static set	5602-1000 N4		

## StopCock PA, electroconductive



Commercially available spigots made of the materials polyethylene or polypropylene cannot be used for solvents. The spigot StopCock PA is made of electrically conductive polyamide and therefore perfectly suitable for solvents. StopCock PA fits onto 3/4" outer threads and with the supplied adapter onto 3/4" inner threads and therefore onto nearly all commercially available canisters and barrels where the discharge thread is at the bottom.

- ▶ With discharge angle and rotatable spout preventing drips
- ▶ With tapered spout for bottles with narrow openings with a diameter from 6 to 8 mm
- ▶ Media-contacting parts PA conductive to electricity and PTFE
- ▶ Supplied with PA adapter conductive to electricity for 3/4" inner thread

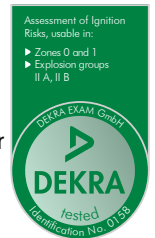

**⚠ Note the "List of Chemical Resistance"!**

StopCock PA, electroconductive				
Thread, inflowing side	Thread, outflowing side	Item no.		
3/4" inner thread cap nut	spout/nozzle	0525-1100 N4		
Accessories				
Description	Item no.			
Anti-static set	5602-1000 N4			

## Ball valve PP



Ball valve PP fits all containers with G 3/4" connection thread. It can be attached to nearly all containers with thread adapters. Robust industrial quality, large flow.

- ▶ Suitable for crystallising media
- ▶ Max. 4 bar pressure at 20 °C
- ▶ With connecting cap nut, guaranteed vertical position of the valve
- ▶ Incl. discharge angle
- ▶ Hose nozzle 16 mm Ø
- ▶ Nominal width 11 mm Ø

### Ball valve PP

Item no.

0500-0100



N4

### Accessories

Description

Sealing tape PTFE, width 12 mm, length 12 m

Item no.

0006-4514 N3

## Ball valves PP for barrels



Ball valves for barrels made of PP for barrels with thread connections.

- ▶ Suitable for solidifying media
- ▶ Max. 10 bar pressure at 20 °C
- ▶ Parts in contact with medium PTFE, PP and FKM
- ▶ Individually adaptable, through various accessories

### Ball valves PP for barrels



Thread, inflowing side	Thread, outflowing side	Nominal width mm	Item no.
1/2" outer	1/2" inner	15	0500-0112 N4
3/4" outer	3/4" inner	20	0500-0134 N4
1" inner	1" inner	25	0500-8001 N3
1/2" inner	1/2" inner	15	0500-8002 N3
3/4" inner	3/4" inner	20	0500-8003 N3

### Accessories

Description

Tube nozzles, fixed, straight 1/2" outer

Item no.

8545-0012 N3

Tube nozzles, fixed, straight 3/4" outer

8545-0034 N3

Tube nozzles, fixed, straight 1" outer

8545-0100 N3

Tube bend, fixed, 1/2" outer

8547-0012 N3

Tube bend, fixed, 3/4" outer

8547-0034 N3

Tube bend, fixed, 1" outer

8547-0100 N3

Adapter for ball valve, Coarse thread Tri-Sure 2" outer, 3/4" inner

0600-0140 N3

Adapter for ball valve, Fine thread 2" outer, 3/4" inner

0600-0180 N3

Sealing tape PTFE, width 12 mm, length 12 m

0006-4514 N3

## Ball valve PP, food



Ball valve made of PP with outer / inner thread, fibre-glass reinforced, ball made of PP, handle with O-ring made of food-safe NBR and seal made of EPDM, PTFE.

- ▶ Max. operating pressure 10 bar (at +20 °C)
- ▶ Max. operating temperature 80 °C
- ▶ Suitable for food

Hose angle bracket, 90°, with cap nut, inner thread and reducing nozzle.



## Spigot "Air"



No additional ventilation opening required, PE, transparent, 3/4" thread connection outside.

- ▶ Self-venting
- ▶ NW 13 mm
- ▶ Seal made of silicone

### Ball valve PP, food

Thread, inflowing side	Thread, outflowing side	Nominal width mm	Item no.
1/2" inner	M29x1,75 outer	15	0500-8102 N3
3/4" inner	M36x3 outer	20	0500-8103 N3
1" inner	M42x3 outer	25	0500-8101 N3
1/2" outer	M29x1,75 outer	15	0500-8202 N3
3/4" outer	M36x3 outer	20	0500-8203 N3
1" outer	M42x3 outer	25	0500-8201 N3

### Accessories

Description	Item no.
Container connection, white 1/2" outer	8533-0012 N3
Container connection, white 3/4" outer	8533-0034 N3
Container connection, white 1" outer	8533-0100 N3
Tube bend with cap nut, thread M29x1,75	8548-0020 N3
Tube bend with cap nut, thread M36x3	8548-0025 N3
Tube bend with cap nut, white, thread M42x3	8548-0030 N3
Sealing tape PTFE, width 12 mm, length 12 m	0006-4514 N3

### Spigot "Air"

Item no.  
0533-0010



N3

## Stainless steel spigot



Very sturdy and robust spigot made of stainless steel AISI 304 (1.4301). The outlet of the spigot turns 360° so it can be adjusted to any required position. With a practical suspension device for filling container and eyelet for shutting off the spigot.

- ▶ Seals PTFE, FKM
- ▶ Self-closing
- ▶ Thread connection 3/4"
- ▶ Lockable
- ▶ NW 10 mm

### Stainless steel spigot

Item no.  
0535-0020



N4

## Spigot "Brass"



Barrel tap for petrochemical liquids, closed independently when not used (increased safety), thread connection 3/4" on the outside.

- ▶ Seals NBR
- ▶ Self-closing
- ▶ NW 10 mm

### Spigot "Brass"

Item no.  
0535-0010



N4

## Adapter set LaboPlast®



Adapter set consisting of:

- ▶ Thread adapter 3/4" - Hünersdorff
- ▶ Thread adapter 3/4" - Kautex
- ▶ Thread adapter 3/4" - cylindrical G 3/4" barrel thread
- ▶ Thread adapter 3/4" - conical R 3/4" barrel thread
- ▶ Hexagonal key for thread adapter



## Thread adapters LaboPlast® 3/4"



① Thread adapter 3/4" - Hünersdorff

② Thread adapter 3/4" - Kautex

③ Thread adapter 3/4" - cylindrical G 3/4" barrel thread

④ Thread adapter 3/4" - conical R 3/4" barrel thread

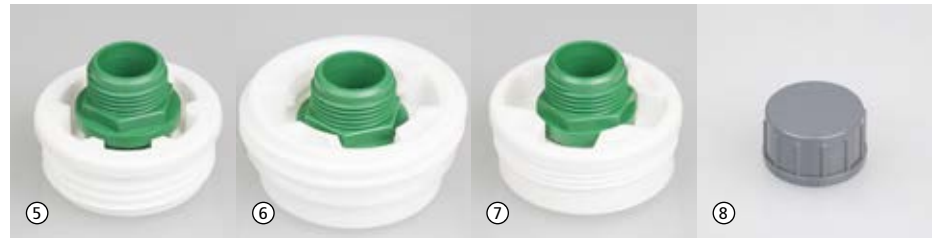

⑤ Thread adapter 3/4" - coarse thread, Tri-Sure 2"

⑥ Thread adapter 3/4" - coarse thread, Mauser 2"

⑦ Thread adapter 3/4" - fine thread 2"

⑧ Captive cap for 3/4"



StopCock spigots, ball valves and other accessories can be connected to most commercially available containers, with the LaboPlast® thread adapters. All adapters have a standard outer thread R 3/4".

⑨ Hexagonal key for thread adapter

### Thread adapter set LaboPlast®

Item no. 0600-0050 N4

	Thread, outflowing side	Thread, inflowing side	Colour	Material	Item no.
①	22x4 (Hünersdorff)	G 3/4"	red	PP	0600-0010 N4
②	20x4 (Kautex)	G 3/4"	blue	PP	0600-0020 N4
③	G 3/4"	G 3/4"	black	PP	0600-0150 N4
④	R 3/4"	G 3/4"	green	PP	0600-0030 N4
⑤	S 56x4 (Tri-Sure)	G 3/4"	green/white	PP/PE	0600-0094 N4
⑥	S 70x6 (Mauser)	G 3/4"	green/white	PP/PE	0600-0120 N4
⑦	G 2"	G 3/4"	green/white	PP/PE	0600-0190 N4
⑧	G 3/4"		grey	PVC	0600-0090 N4
⑨	hexagonal key for thread adapter		blue	PP	0600-0001 N4

## Spigot Jumbo, with tap



Spigot with tap for G 2" barrel thread, 50 mm flow, for viscous media such as lacquers, glue, shampoo.

- ▶ Cost-effective tap
- ▶ PE, brown
- ▶ Seal made of EPT

## Barrel valve



The barrel valve enables quick and clean emptying even with highly viscous liquids.

It is suitable for metal barrel with 2" BSP TriSure metal barrel screw joint.

The barrel valve enables opening the barrel closure as well as emptying and reclosing it even with lying, full barrels without having to move them.

- ▶ Glas fibre reinforced PP
- ▶ Seals NBR

### Spigot Jumbo, with tap

Item no.  
0534-0020



N4

### Barrel valve

Item no.  
0536-0010



N4

## IBC discharge valves

The IBC discharge valve is a sturdy, high-quality ball valve with a hose connection and connection adapter including seal, for standard thread S 60x6 external or 1" external, designed to fit all commonly used European IBC containers.

With the appropriate thread, the discharge valve can also be screwed directly onto the original discharge valve that is already on the IBC tank if the original valve is leaking or faulty. In this way the IBC discharge valve ensures fast and reliable residual emptying of the container with good dosing.

The discharge valve is an indispensable accessory to ensure a professional connection of the hose or for filling from your IBC container.

- ▶ 1" flow
- ▶ Suitable for connection threads S 60x6 external or 1" external
- ▶ Discharge valve and sealing cap PP fibreglass-reinforced, ball and adapter PP
- ▶ Max. operating pressure 10 bar (at +20 °C)
- ▶ Max. operating temperature 80 °C

① IBC discharge valve with 90° hose nozzle and sealing cap. The hose can also be closed with the enclosed sealing cap. Hose nozzle external PA Ø 30 mm, suitable for flexible hoses.

② IBC discharge valve with innovative hose screw connection. The hose screw connection allows you to attach a wide range of hoses quickly, easily and reliably. No additional hose clamp is needed. Hose fitting PP/POM, external Ø 25 mm.



### ① IBC discharge valve with angle discharge

Item no.  
0534-0002



N3

### ② IBC discharge valve with hose screw connection

Item no.  
0534-0001



N3

## Drain safety stand



Residual liquid from pump tubes or samplers can be reliably collected with the drain safety stand. The safety stand is resistant to diluted bases and acids. The collecting container can be filled with a neutralisation medium which dilutes and neutralises residual liquid.

The stand pipe is mounted on the wall with sturdy pipe clamps. The pipe clamps can simply be opened to remove the safety stand.

The container for collecting liquid can be unscrewed, making it convenient to replace or empty.

### Drain safety stand

Total length cm	Inner dia. mm	Item no.
117	35	5618-1000 N4

## General pump accessories



Threads can be ideally sealed with the sealing tape for threads made of PTFE. Low abrasion, excellent chemical resistance, temperature resistant from -80 °C to +260 °C.

### Sealing tape PTFE

Width mm	Length m	Item no.
12	12	0006-4514 N3

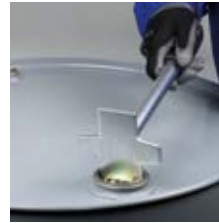

Universal barrel key for effortless opening even of tight barrel closures 3/4" to 2". An unbreakable tool made of zinc-plated steel.

### Universal barrel spanner

Item no.
5690-0090 N4



Hexagonal nut with inner thread.



Flat seals made of Polyethylene, transparent fitting outer or inner thread.

► PE

### Hexagonal nuts

Thread	Material	Item no.
1/2"	HDPE	8537-0012 N3
3/4"	HDPE	8537-0034 N3
1"	HDPE	8537-0100 N3
2"	PP	8537-0200 N3

### Flat seals, PE

Thread	Model	Pieces per pack	Item no.
1/2"	fits outer thread	10	8538-0012 N3
3/4"	fits outer thread	10	8538-0034 N3
1"	fits outer thread	10	8538-0100 N3
2"	fits outer thread	10	8538-0200 N3
1/2"	fits inner thread	10	8539-0012 N3
3/4"	fits inner thread	10	8539-0034 N3
1"	fits inner thread	10	8539-0100 N3